

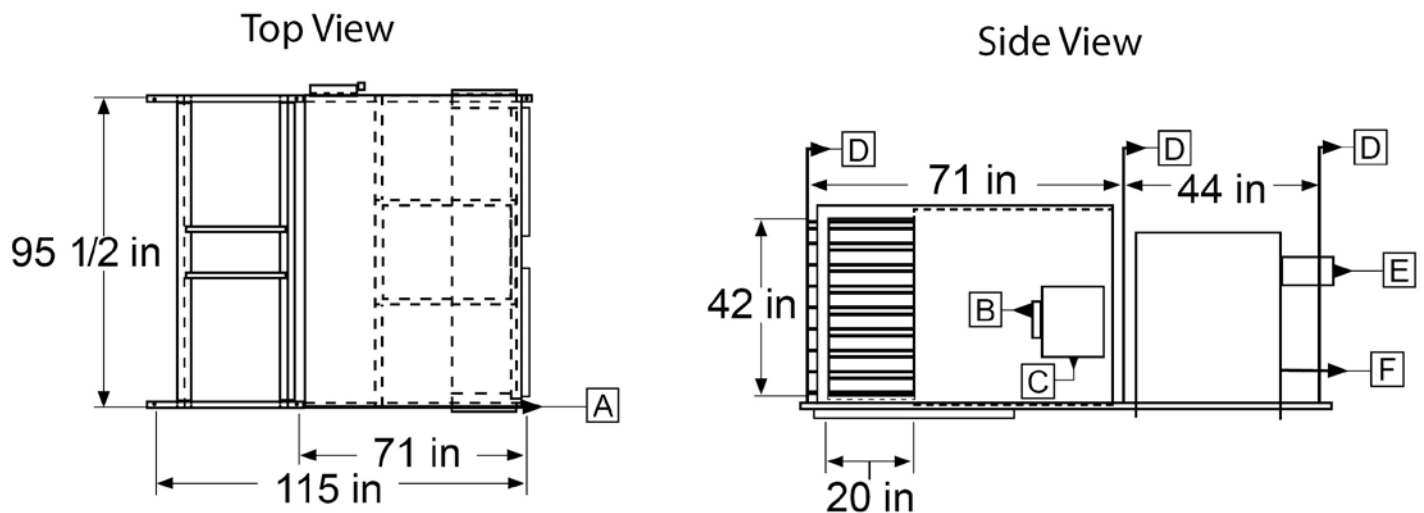

4790 West 73rd Street | Indianapolis, Indiana 46268
 Phone: 317-290-8500 | Fax: 317-290-1900
 aes2@sbcglobal.net | www.aesrack.com

PROJECT:	LOCATION:
ARCHITECT:	ENGINEER:
CONTRACTOR:	DATE:

93% EFFICIENT THE FIRST TRUE "GREEN HEATING SYSTEM"



- A) (6) 1/2" MOUNTING HOLES ON CENTER
 - B) SERVICE SWITCH ELECTRICAL CONNECTION POINT
 - C) 14" x 16" CONTROL PANEL
 - D) 3/8" ALL-THREAD HANGING ROD
 - E) 4" FLUE VENT PIPE
 - F) 3/4" INLET GAS CONNECTION
- NOTE – UNIT HEATER FLUE AND GAS CONNECTION WILL VARY WITH UNIT HEATER SIZE AND MFG (See attached submittal)
 - 1,700 lbs
 - HORIZONTAL OR VERTICAL CONCENTRIC VENT KITS
 - 6" INLET COMBUSTION AIR
 - 4" FLUE VENT
 - 1/2" CONDENSATE DRAIN ON BACK OF HEATER

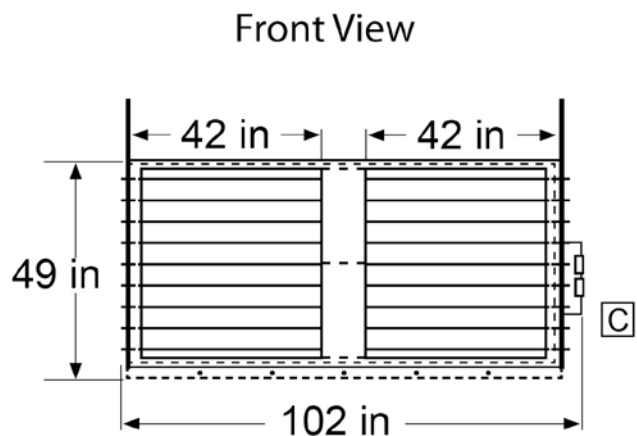

QTY	UNIT MODEL	2/ FAN	HP	AMPS	CFM	SONES	TRANS	VOLTS	F/DISC
1	ER-242-620	115 / 1	3 / 4	28	33,000	12.6			

QTY	U/MODEL	VOLTS	AMPS	BTU/INPUT	BTU/OUTPUT	FLUE	GAS/CON	G/PRE
2	PTC 310	115 / 1	8	310,000	288,000	4"	3/4"	6"