

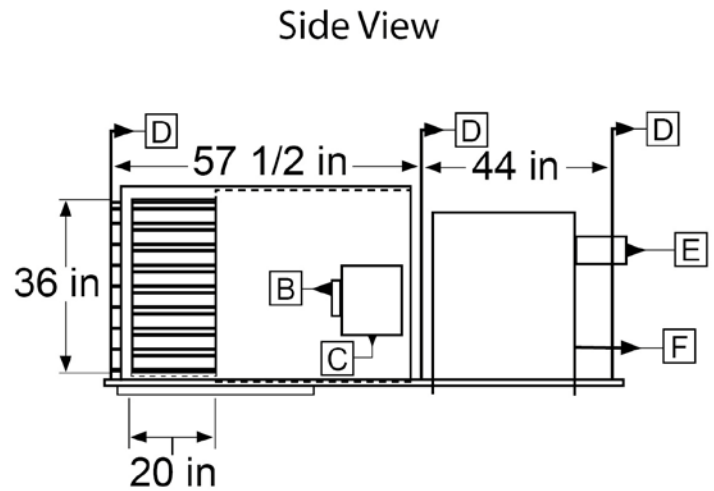

4790 West 73rd Street | Indianapolis, Indiana 46268
 Phone: 317-290-8500 | Fax: 317-290-1900
 aes2@sbcglobal.net | www.aesrack.com

PROJECT:	LOCATION:
ARCHITECT:	ENGINEER:
CONTRACTOR:	DATE:

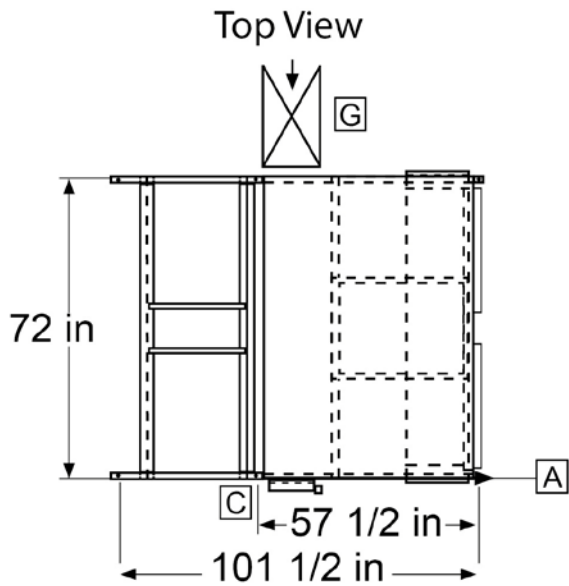

- A) (6) 1/2" MOUNTING HOLES ON CENTER
- B) SERVICE SWITCH ELECTRICAL CONNECTION POINT
- C) 14" x 16" CONTROL PANEL
- D) 3/8" ALL-THREAD HANGING ROD
- E) 5" FLUE VENT PIPE
- F) 3/4" INLET GAS CONNECTION
- G) SUPPLY DUCT

- NOTE – UNIT HEATER FLUE AND GAS CONNECTION WILL VARY WITH UNIT HEATER SIZE AND MFG (See attached submittal)
- 1,400 lbs

Front View

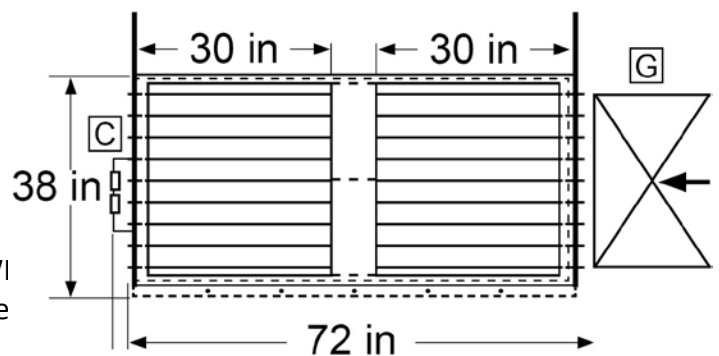

QTY	UNIT MODEL	2/ FAN	HP	AMPS	CFM	SONES	TRANS	VOLTS	F/DISC
1	ER-230-500	115 / 1	1/2	24	18,000	12.6			

QTY	U/MODEL	VOLTS	AMPS	BTU/INPUT	BTU/OUTPUT	FLUE	GAS/CON	G/PRE
2	PDP 250	115 / 1	8	250,000	200,000	5"	3/4"	6"