

93% EFFICIENT
THE FIRST TRUE "GREEN HEATING SYSTEM"

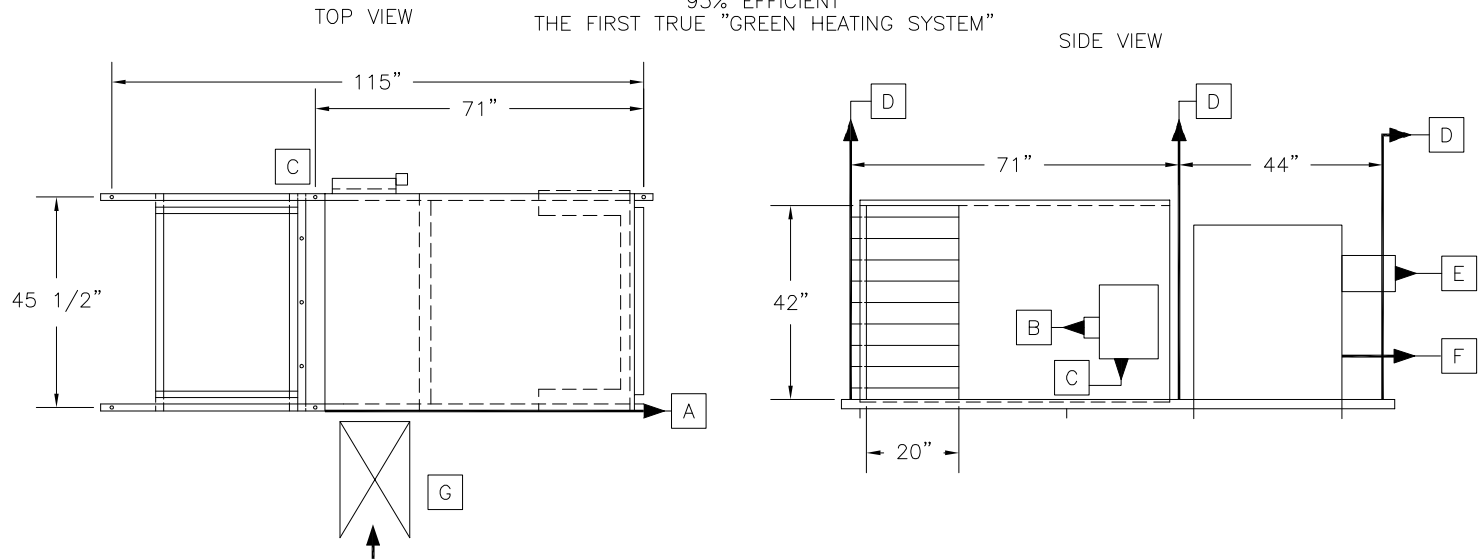

- A) (6) 1/2" MOUNTING HOLES ON CENTER
- B) SERVICE SWITCH ELECTRICAL CONNECTION POINT
- C) 14"x16" CONTROL PANEL
- D) 3/8" ALL-THREAD HANGING ROD
- E) 4" FLUE VENT PIPE
- F) 3/4" INLET GAS CONNECTION
- G) SUPPLY DUCT
- NOTE-UNIT HEATER FLUE AND GAS CONNECTION WILL VARY WITH UNIT HEATER SIZE AND MFG (SEE ATTACHED SUBMITTAL)
- 1700 LBS
- HORIZONTAL OR VERTICAL CONCENTRIC VENT KITS
 - 6" INLET COMBUSTION AIR
 - 4" FLUE VENT
 - 1/2" CONDENSATE DRAIN ON BACK OF HEATER

QTY	UNIT MODEL	1/FAN	HP	AMPS	CFM	SONES	TRANS	VOLTS	F/DISC
1	ER-142-310	115/1	3/4	14	16,500	12.6	5 KVA	460/1	YES

QTY	U/MODEL	VOLTS	AMPS	BTU/INPUT	BTU/OUTPUT	FLUE	GAS/CON	G/PRE
1	PTC 310	115/1	8	310,000	288,000	4"	3/4"	6"